

JOY

cocktail





■

Sulle terrazze delle metropoli, di fronte al mare o con i monti attorno, JOY cocktail c'è.

*On city terraces,
on the seafront
or in mountain settings,
JOY cocktail there is.*

**La famiglia JOY si allarga
con l'arrivo di JOY cocktail:**

pratico, dinamico e poco ingombrante.
Ideale per locali, eventi, feste e matrimoni.
Qualità BRX ad un prezzo conveniente.

**LA LINEA JOY È COMPLETAMENTE
REALIZZATA NEI NOSTRI STABILIMENTI
IN ITALIA.**

**The JOY family expands
with the arrival of JOY cocktail:**

practical, dynamic and not bulky.
Ideal for clubs, events, parties and weddings.
BRX quality at affordable price.

**THE LINE JOY IS COMPLETELY
MANUFACTURED IN OUR
PLANTS IN ITALY.**



**JOY cocktail è un banco di arredo
per gli ambienti più esclusivi**
*JOY cocktail is a furniture counter
for the most exclusive environments*

Composizione JOY cocktail: pannello decorativo nobilitato Bianco Torano FC13

JOY cocktail composition: decorative panel melamine Bianco Torano FC13

JOY, la cocktail station pratica ed elegante su ruote.

JOY, the practical and stylish cocktail station on wheels.

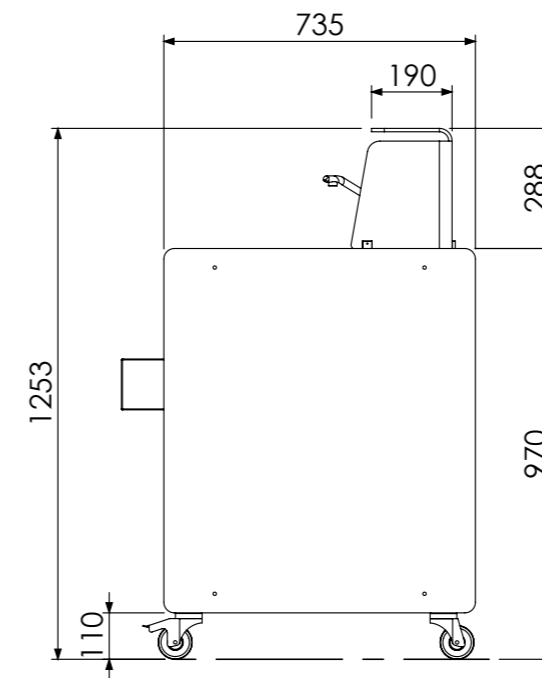

Dotato di ruote girevoli con freno, può essere facilmente spostato dove occorre.

Equipped with swivel wheels with brakes, it can be easily moved where needed.

LATO CLIENTE CUSTOMER SIDE



- Teca plexiglas**
Plexiglas sneeze guard
- Top acciaio inox
finitura scotch-brite**
*Stainless steel top
scotch-brite finish*
- Pannello frontale
acciaio bianco
(personalizzabile con grafica
decorativa) o nobilitato**
*White steel front panel
(customizable with decorative
graphic) or melamine panel*
- Fianco acciaio bianco**
White steel side panel

LATO OPERATORE OPERATOR SIDE



- Parte posteriore acciaio inox**
Stainless steel rear part
- Vano a giorno**
Open compartment
- Vano tecnico**
Technical compartment

Ruota con freno
Wheel with brake



Ideale sia per un uso interno che esterno
Ideal both for indoor and outdoor use



JOY cocktail canalizzato con banco di servizio. Pannello con grafica Giallo E 485.7
JOY cocktail multiplexed to a service counter. Panel with graphic Yellow E 485.7

Crea la tua postazione cocktail.

Build up your own cocktail station.

I banchi cocktail possono essere indipendenti o canalizzati ad un banco di servizio.

The cocktail counters can be standalone or multiplexed to a service counter.

BRX JOY



46

JOY, la cocktail station dove vuoi.

JOY, the cocktail station wherever you want.



BRX JOY

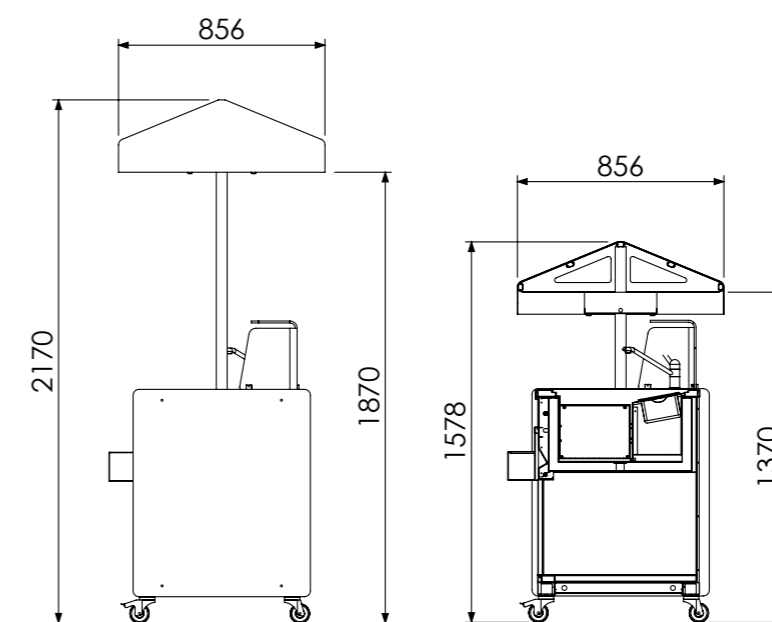

Disponibile in versione mobile con ruote oppure in versione fissa con piedini regolabili. Possibilità di inserimento di cappottina telescopica regolabile in altezza.

Available both in mobile version equipped with wheels or fixed with adjustable leveling feet. Possibility of adding a telescopic sunshade curtain adjustable in height.

47

JOY cocktail: gamma e componibilità.

*JOY cocktail:
range and modularity.*

JOY cocktail può essere indipendente
o canalizzato ad un banco di servizio.
Il lavello può essere posizionato a destra
o a sinistra.

*JOY cocktail can be standalone
or multiplexed to a service counter.
The sink can be positioned on the right
or left.*

L. 1006



L. 1506



L. 1256

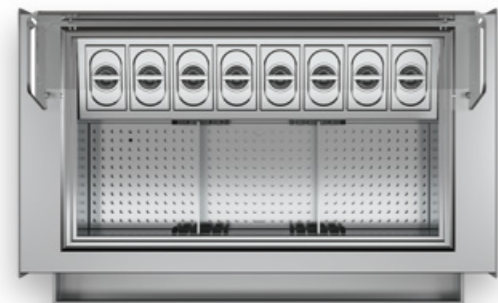

L. 1756



L. 1506



L. 2006

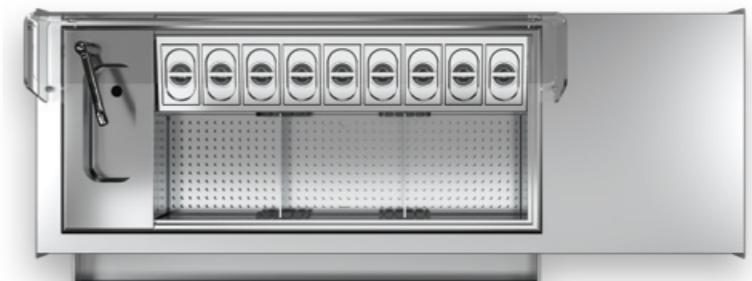

JOY cocktail: accessori disponibili.

*JOY cocktail:
available accessories.*



Vano portabottiglie
Bottle holder

optional



Vaschette fruttini
Topping trays

optional



Vasca coibentata neutra con divisori interni
Neutral insulated tub with inner dividers



Vasca coibentata neutra con divisori interni
Neutral insulated tub with inner dividers



Lavello a sinistra
Sink on left

Lavello a destra
Sink on right



Piano cassa
Shelf for cash register

optional



Illuminazione a LED per mensola
LED lighting for shelf

optional

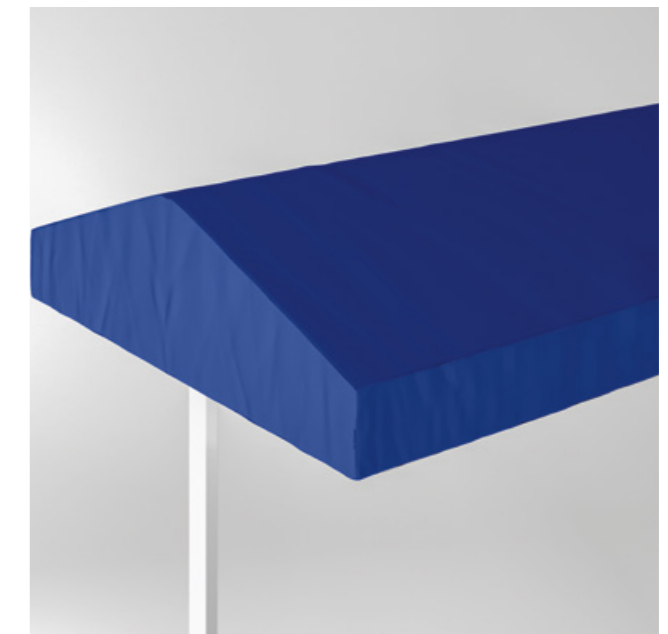

Cappottina in tessuto acrilico
Acrylic fabric sunshade curtain



**Ideale per rendere indimenticabili
feste ed eventi.**

Ideal for making parties and events memorable.

JOY cocktail canalizzato con banco di servizio. Pannello con grafica Rosso E 483.9.

JOY cocktail multiplexed to a service counter. Panel with graphic Red E 483.9.

JOY banchi di servizio.

JOY service counters.

Ampia gamma di banchi di servizio attrezzabili come vuoi.
Wide range of service counters that can be equipped as you wish.

Alcune combinazioni possibili.
Some possible combinations.



Cassetto cassa e tramoggia rifiuti H. 500
Cash drawer and garbage hopper H. 500

Vano neutro con anta
Neutral compartment with hinged door

Cassetto cassa e vano a giorno
Cash drawer and open compartment

Vano a giorno
Open compartment

Top acciaio inox finitura scotch-brite
Stainless steel top scotch-brite finish

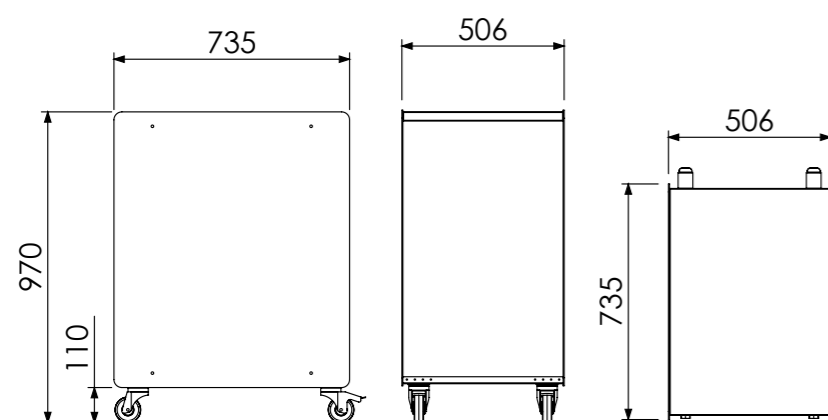

A seconda delle necessità è possibile posizionare il banco di servizio a destra o sinistra di JOY cocktail.
Depending on your needs, the service counter can be positioned to the right or left of JOY cocktail.



Pannello frontale acciaio bianco (personalizzabile con pellicola decorativa) o nobilitato
White steel front panel (personalizable with decorative film) or melamine panel

Parte posteriore acciaio inox
Stainless steel rear part

LATO CLIENTE / CUSTOMER SIDE



I banchi di servizio possono essere indipendenti o canalizzati ad un JOY cocktail.

The service counters can be standalone or multiplexed to a JOY cocktail.

LATO OPERATORE / OPERATOR SIDE



Materiali e finiture.

Materials and finishes.

GRAFICHE DECORATIVE (da applicare su pannello acciaio bianco)

DECORATIVE GRAPHICS (to be stick to the white steel panel)

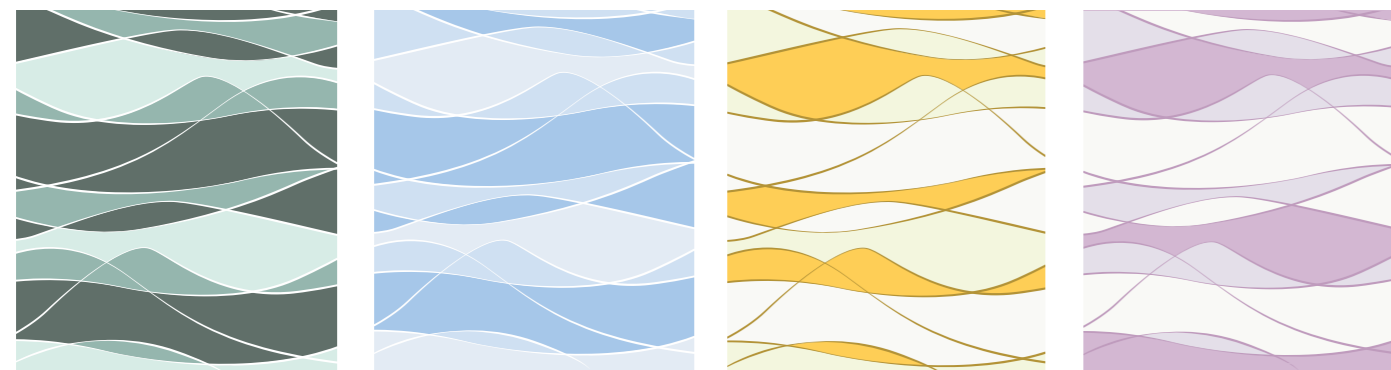

cod J01 cod J02 cod J03 cod J04

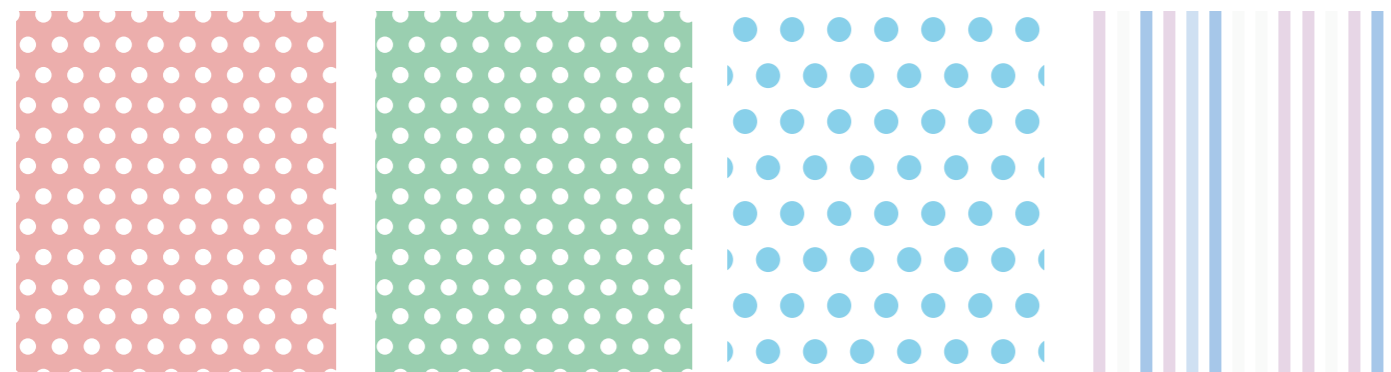

cod J11 cod J12 cod J13 cod J21

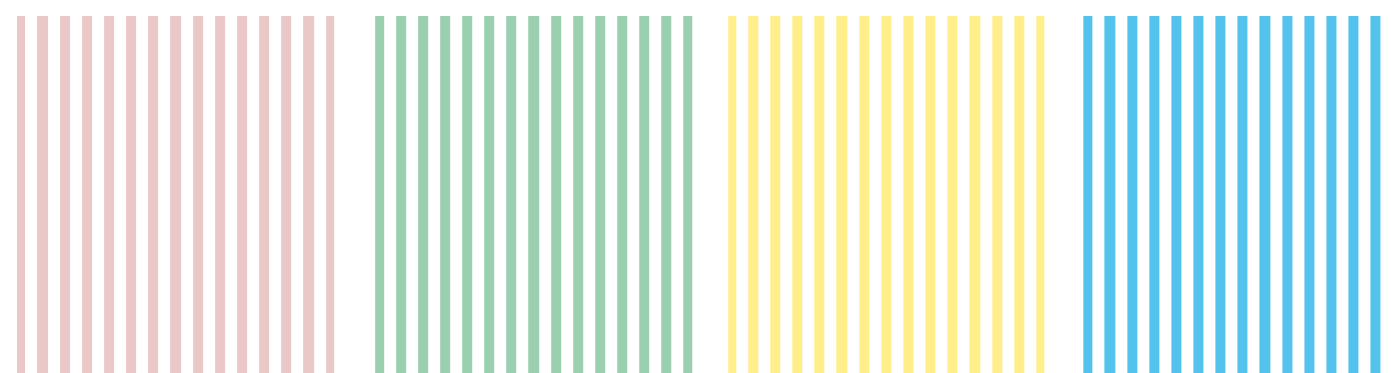

cod J22 cod J23 cod J24 cod J25

GRAFICHE DECORATIVE (da applicare su pannello acciaio bianco)

DECORATIVE GRAPHICS (to be stick to the white steel panel)

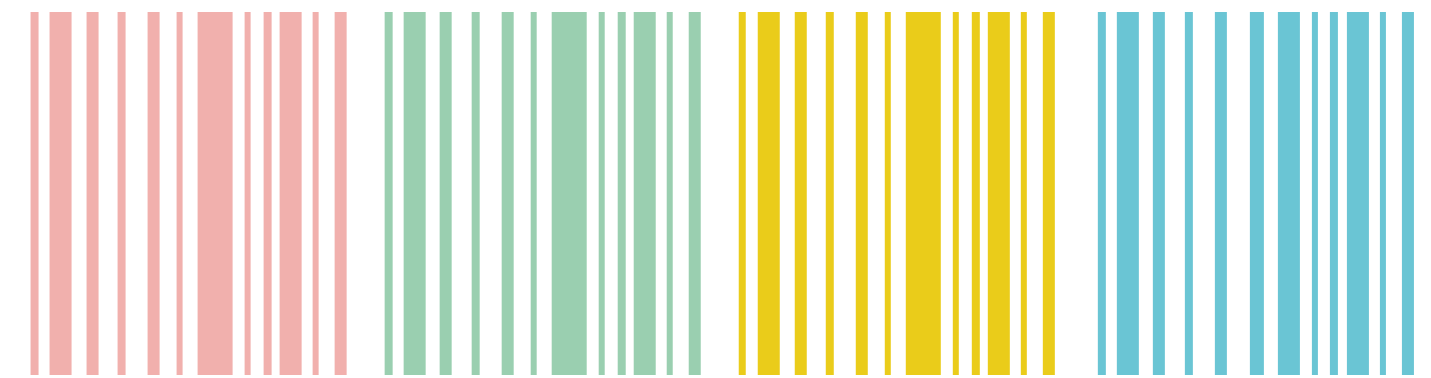

cod J31 cod J32 cod J33 cod J34

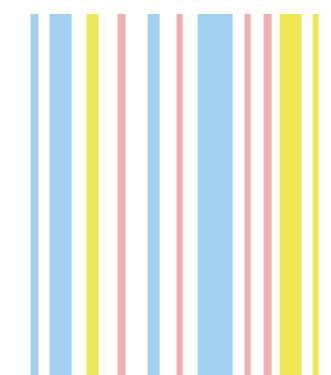

cod J35

GRAFICHE DECORATIVE TINTA UNITA (da applicare su pannello acciaio bianco)

SOLID COLOR DECORATIVE GRAPHICS (to be stick to the white steel panel)



E 486.8 Blu / Blue **E 485.7** Giallo / Yellow **E 483.9** Rosso / Red **E 484.8** Acqua Marina / Sea water

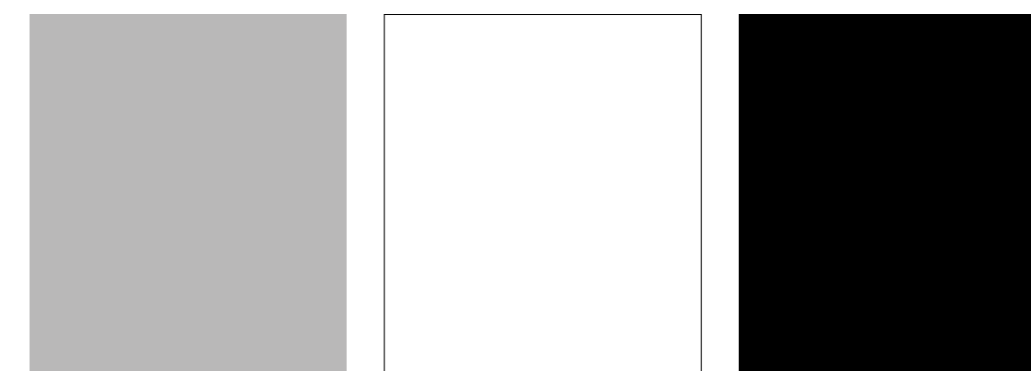

E 482.1 Grigio / Grey **E 480** Bianco / White **E 487** Nero / Black

Materiali e finiture.

Materials and finishes.

PANNELLO DECORATIVO NOBILITATO (in sostituzione del pannello acciaio bianco)

MELAMINE DECORATIVE PANEL (in place of white steel panel)



SHERWOOD S071



SHERWOOD S073



PEMBROKE S122



PEMBROKE S128



MATRIX B007

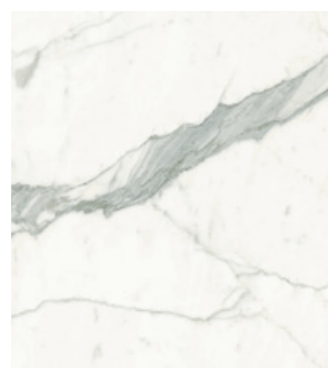

BIANCO TORANO FC13

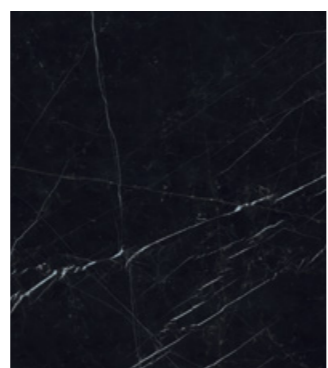

NERO MONTILLA FC18



NERO GRAFITE U12007 MP
Graphite black U12007 mp

CAPPOTTINA IN TESSUTO ACRILICO / ACRYLIC FABRIC SUNSHADE CURTAIN

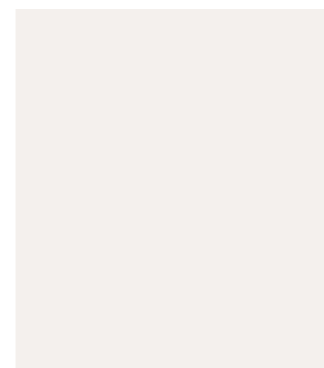

50-20
Bianco / White



55-30
Grigio / Grey



P023
Blu / Blue